

ISOMETRIC VIEW  
SCALE: NONE

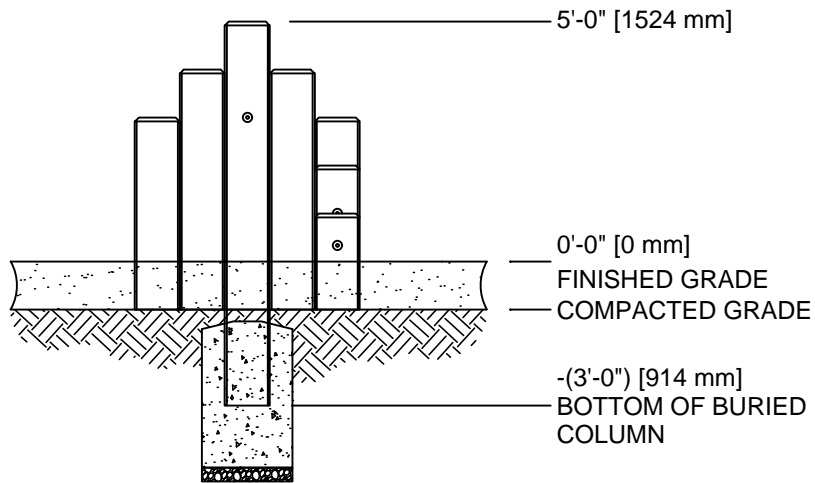

FRONT VIEW  
SCALE 1/4"=1'-0"

SAFE USE ZONE

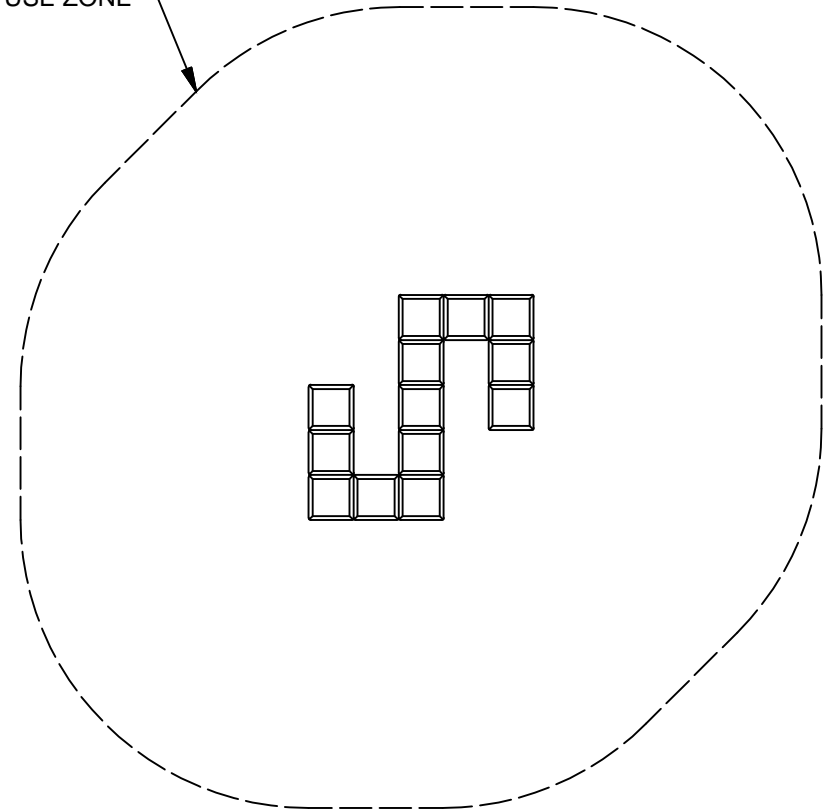

EQUIPMENT ONLY:  
4'-9" x 4'-9" (1.6m x 1.6m)

MINIMUM SAFE USE ZONE:  
16'-9" x 16'-9" (5.2m x 5.2m)

PLAN VIEW WITH USE ZONE  
SCALE 1/4"=1'-0"



NOTE:  
CONCRETE FOOTING AND NO. 4 REBAR (BY OTHERS) PER LOCAL SOIL CONDITIONS. CONSULT PROJECT ENGINEER FOR EXACT REQUIREMENTS.

Date	Revision	By
△		
△		
△		
△		
Scale	Drawn by: DGR	07-02-18
NOTED	Ck'd by: CL	07-02-18



**COLUMBIA CASCADE COMPANY**  
Makers of TimberForm®, PipeLine®, RePlay®

1300 S.W. Sixth Avenue, Suite 310  
Portland, Oregon 97201-3464  
U.S.A.

Telephone 503/223-1157  
Facsimile 503/223-4530

This drawing reveals the copyrighted intellectual property of Columbia Cascade Company. Not for use by others without our express, written authorization.

WWW.TIMBERFORM.COM

Title:  
CLASSIC TIMBERFORM  
MODEL NO. 4500-512  
STEPPING COLUMNS

Drawing No.  
W-4500-512

Sheet  
1 of 1