

ISOMETRIC VIEW
SCALE: NONE

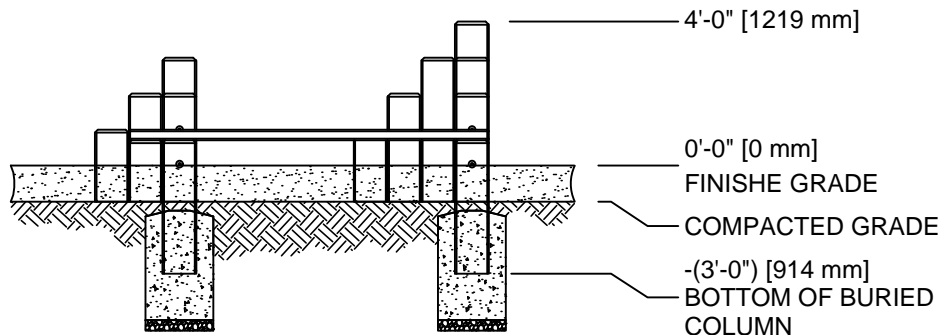

FRONT VIEW
SCALE 3/16"=1'-0"

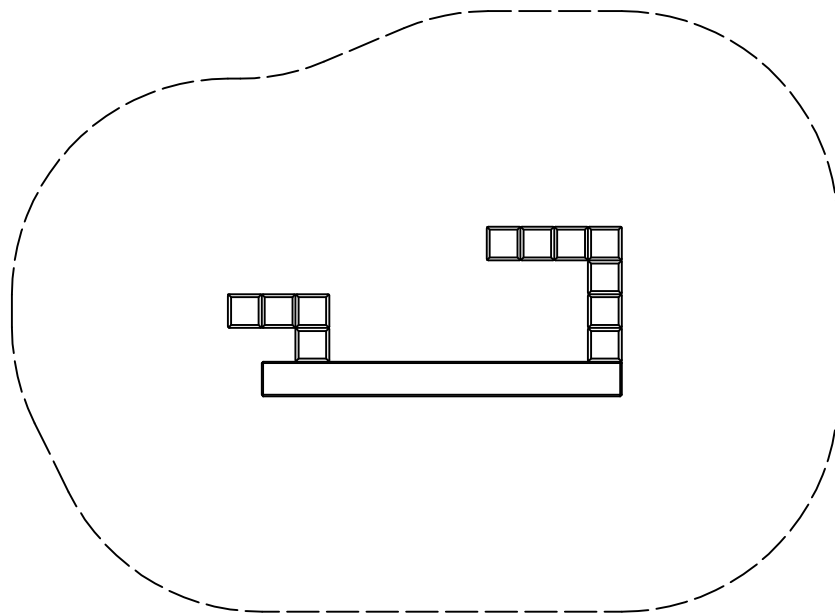

EQUIPMENT ONLY:
11'-0" x 4'-9" (3.4m x 1.6m)

MINIMUM SAFE USE ZONE:
23'-0" x 16'-9" (7.1m x 5.2m)

PLAN VIEW WITH USE ZONE
SCALE 3/16"=1'-0"



NOTE:
CONCRETE FOOTING AND NO. 4 REBAR (BY OTHERS) PER LOCAL SOIL CONDITIONS. CONSULT PROJECT ENGINEER FOR EXACT REQUIREMENTS.

Date	Revision	By
△		
△		
△		
△		
Scale	Drawn by: DGR	05-14-18
NOTED	Ck'd by: CL	05-14-18

COLUMBIA CASCADE COMPANY
Makers of TimberForm®, PipeLine®, RePlay®

1300 S.W. Sixth Avenue, Suite 310
Portland, Oregon 97201-3464
U.S.A.

Telephone 503/223-1157
Facsimile 503/223-4530

This drawing reveals the copyrighted intellectual property of Columbia Cascade Company. Not for use by others without our express, written authorization.

WWW.TIMBERFORM.COM

Title:
CLASSIC TIMBERFORM
MODEL NO. 4500-513
STEPPING COLUMNS

Drawing No.
W-4500-513

Sheet
1 of 1